

HOFMANN®



Geoliner 660

IMAGE WHEEL ALIGNER

HOFMANN IMAGING TECHNOLOGY

Set-Up To Readings In Under 2 Minutes

- Do more alignments in less time
- So easy to use that technicians will actually sell more alignments
- Improves revenue with higher productivity
- Non-electronic wheel sensor targets eliminate calibrations, wheel sensor maintenance and cables
- No comebacks due to calibration problems



1

Mount wheel targets



2

Roll vehicle back or pull forward only 8"

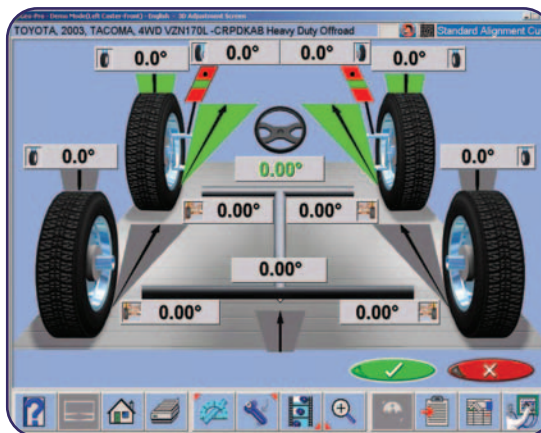

3

Obtain all alignment readings in under 2 minutes. Adjust vehicle using live measurements.



VEHICLE ORIENTATION DIRECTIONAL INDICATOR

Multi-Processor Cameras*

VODI™* Graphic Display - Graphic overlay around each camera provides visual and directional assistance to the operator during the alignment measurements.

Tires represent (4) targets.

GREEN LED indicates target found.

RED LED indicates target missing.

Left and Right direction arrows illuminate indicating direction wheels are turning during Caster and Turning Radius measurements.

Up and Down direction arrows illuminate indicating vehicle movement direction during Positioning/rollback.

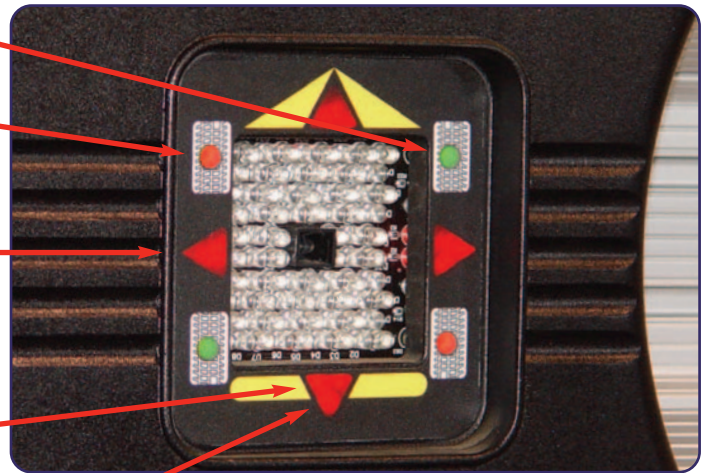

All 4 arrows illuminated indicate STOP.

EASY TO USE OPERATOR INTERFACE

A simple keystroke opens the advanced diagnostic programs which walk the technician through to completion.

Elevated Caster & Camber

A-Arm Adjust

E-Z Toe*

Live Cradle Adjust



Drag Link 1

Drag Link 2

Shims & Kits

Ford Bushing Program

* Patented and/or Patent Pending Features

25" UNIVERSAL WHEEL CLAMPS

Universal Wheel Clamps with *NEW* Shatterproof Targets

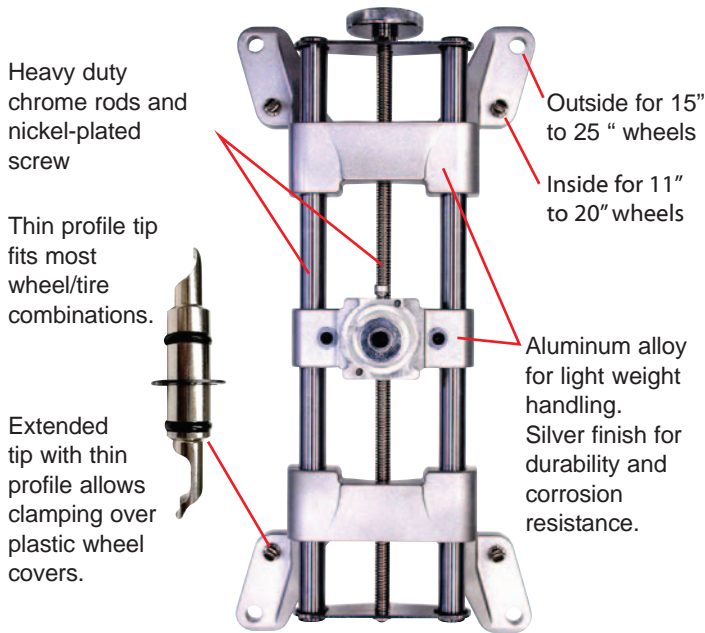

Tire Clamp Adapter

(EAK0268J63A) allows accurate clamping without risk of scratching the wheel finish. Tire clamps provide secure attachment to wheel while plastic sleeves placed over standard claws ensure proper placement and wheel protection.



Optional Clamp Extensions

(EAK0268J62A) increase maximum clamping diameter to 30 inches.



AVAILABLE OPTIONS

EZ-Access Software*

For vehicles on which tire size or body style makes adjustments difficult, our software allows a "wheels off" alignment. It's perfect for quick and easy installment of aftermarket suspension kits as well as OEM adjustments.



Intuitive Measurement

Measurement of caster, toe-out on turns and maximum steering angle can be done by simply turning the steering wheel ONCE to the left and right. The system recognizes your steering input and anticipates the next measurement.

Animated Adjustment Aid

Technicians benefit from on-screen visual aids for vehicle-specific adjustments, including instructions, comments and necessary tools.



* Patented and/or Patent Pending Features

EXCLUSIVE CUTTING EDGE ALIGNMENT DIAGNOSTIC TOOLS

ADVANCED VEHICLE MEASUREMENTS

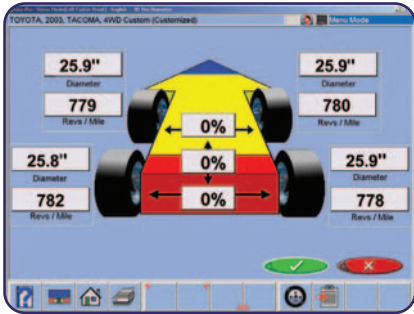

3-Dimensional modeling also generates very accurate distance measurements.

Rolling Radius Measurements™*

Same size tires from different manufacturers may not always be the same size/diameter. This can cause steering pull which is nearly impossible to diagnose without this tire measuring feature.

Wheel Dimensioning Plus*

The 660's 3-dimensional modeling software performs spindle measurements: front and rear wheel setbacks, track widths, and cross diagonal measurements which will indicate when possible frame or unbody damage may exist and requires correction before a proper alignment can be done.



2-Wheel Alignment Capability
Great for performing 2-wheel alignment checks on fixed rear axle vehicles. Camber and Toe measurements in under one minute!



Box crossed indicating that the rear targets will not be used.



Single wheel positioning is available in 2-wheel mode for large vehicles.

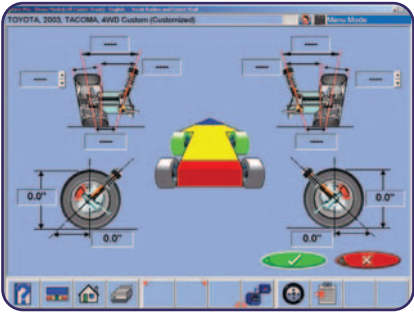

Scrub Radius*, Caster Trail*, SAI and Included Angle readings

Caster Trail*, Scrub Radius*, SAI & Included Angle Measurement Screen

This feature is available only with the 660's software. It provides a graphical representation of Caster Trail, Scrub Radius and Included Angle. The operator must enter the tire width in order to calculate scrub radius, but the 660 enters all other required parameters automatically upon completion of rollback/positioning.

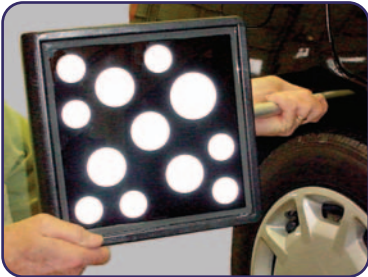

Simple implementation of the Ride Height TIP.

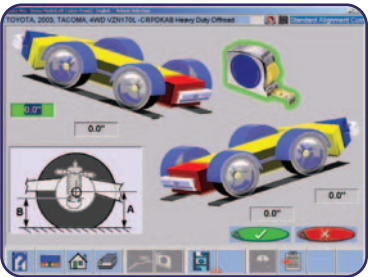

Live camera view aids technician in target placement.

Ride Height Technology*

As the system provides step-by-step instructions, simply hold the TIP (Target Imaging Pointer) against the vehicle touch points and this exclusive new digital imaging tool measures OEM specifications to ±0.05 inch. The screen provides a live camera view to aid in target placement and an audible signal to indicate when each measurement is complete.

* Patented and/or Patent Pending Features

Geoliner 660

HOFMANN®



**Windows® based Image Technology with both speed
and accuracy for the automotive professional**

FEATURES

Alignment Display

- Front Readings
- Rear Readings
- All Readings
- Zoom Readings
- Individual Camber
- Individual Toe
- Individual Caster
- SAI & Thrust Angle
- Included Angle
- Front & Rear Setback
- Toe Out On Turns
- Front Caster (-28° to +28°)
- Front & Rear Camber (-15° to +15°)
- Front & Rear Toe

Meter And All Reading Screens

- Advanced Alignment Measurements with reading/specifications and cross values
- Meter Screens
- Live 3-D Modeling*

Four-way System Controls

- Voice Align™ (optional)*

(For-way System Controls continued)

- Remote control
- Console keyboard
- Optical Mouse

Other Software Features Alignment Assistance

- 3-D Animation
- Live Video Helps (Multimedia)
- Multiple A-Arm Adjust
- Adjust Camber Only
- Elevated Adjustments
- Active Cradle Adjustments
- Drag Link Adjust
- 4-Wheel Steer Adjust
- Rear Shim Programs
- E-Z Access (wheels off)
- Driver Complaint Diagnostics
- A/I Alignment Diagnostics
- Adjustment Help Files
- E-Z Track Data Base
- Align Specs -30 years
- E-Z Toe
- Suspension Plus

(Other Software Features continued)

- Ride Height Charting
- Wheel Dimensioning Plus
- User Login

Advanced Measurements

- Scrub Radius*
- Caster Trail*
- Pro-Ackermann™*
- Rolling Radius*
- Cross Diagonal*
- Steering Asymmetry with Diagnostics*

Additional Setups

- Programmable Alignment Wizards
- OEM Wizards
- Set-back in Align Path
- Thrust Align Only
- Selectable Cross Values
- 28 Languages
- Custom Inspections
- Multiple Print Formats
- Inspections and Reports
- Shop Management Interface

SPECIFICATIONS

Computer Alignment Systems

- 19" color flat-screen monitor
- Mobile deluxe cabinet
- State-of-the-art Dell® PC
- DVD drive / 3.5 floppy
- Network card
- Color Ink Jet Printer
- Wheel Clamps
- 3-D Animated graphics

Standard Accessories

- Steering wheel holder
- Brake pedal depressor
- Optical Mouse
- Remote controller

Optional Equipment

- Stainless steel turntables 054
- Rollback Kit for Stainless turntables 055
- Roll Forward Kit for 4-post 056

(Optional Equipment continued)

- Stainless Turntables (Hunter/Rotary) (Set: 2) 89261
- Ride Height TIP EAK0256J71A
- Roll Back Kit (Rotary) 89327
- Roll Back Kit (Hunter) 89328
- Adjustable height camera boom EAA0321J19A
- Fixed camera 1-post support EAA0321J01A

Accessories

- Voice Align™ Kit EAK0222J17A
- Alignment Conversion Kit for use w/ 43102 lifts 053ALN
- Heavy Duty Truck Turntables, (Set: 2) 1260
- Surface Mount Portable Rear Slip Plates, (Set: 2) 64222
- Frame Angle Gauge 8-05320A
- Wheel Clamp Extension (to 30") EAK0268J62A
- Tire Clamp Adapter EAK0268J63A
- Alloy Extension Kit to 25" EAK0222J27A
- Alloy Extension Kit to 25", (Set: 4) EAK0222J27A4
- Alloy Universal Wheel Clamp Kit, (Set: 4) EAK0222J30A

(Accessories continued)

- BMW / MB Alloy Hub Pin Kit EAK0222J28A
- BMW 7 Series / MB A-Class Hub Pin Kit EAK0256J41A
- Porsche Alloy Adapter Kit EAK0222J20A
- Remote Display Readout w/ 30" cable EAK0222J77A
- Quick Clamp Storage Caddy EEWH900A
- Rollback Rubber Pads, (Set: 2) 046
- Convex Mirror 36" wide w/ hardware P-1826
- Honda Grabbers (clamps over wheel covers) 89264
- Hub Adapter Kit (wheel-off Alignment) EAK0222J83A

Equipment Specifications

- Wheel size: 10" - 25"
- Tire diameter: unlimited
- Tread width: 48" - 96"
- Wheel base: 79" - 200"

Power Requirements

- 115V / 1Ph, 50/60 Hz / 6 amp
- 230V / 1Ph, 50/60 Hz / 3 amp

* Patented and/or Patent Pending Features

HOFMANN®

USA



309 Exchange Avenue • Conway, AR 72032
(800) 251-4500 • (501) 450-1581
Fax (501) 450-2085 • www.hofmann-usa.com

HOFMANN®

Canada



6500 Millcreek Drive • Mississauga, ONT L5N 4G4
(800) 267-2185 • (866) 812-5316
Fax (905) 821-2073 • www.hofmann.ca
E-mail: info@hofmann.ca